



BOMBA FORMULA CASAPPA FP30 SO/DO 19T1 3 FUROS

20022 FP30-27-SO 19 T1
 20023 FP30-34-SO 19 T1
 20024 FP30-43-SO 19 T1
 20025 FP30-51-SO 19 T1
 20026 FP30-61-SO 19 T1
 20027 FP30-73-SO 19 T1
 20028 FP30-82-SO 19 T1



BOMBA FORMULA CASAPPA FP40 SO/DO 19T1 - 3 FUROS

20191
 20192
 20193 FP40-87-SO 19 T1
 20194 FP40-109-SO 19 T1
 20195 FP 40-13-SO 19 T1



BOMBA FORMULA CASAPPA FP40 SO/DO 19T1 - 3 FUROS

FP 40-63-S1 06S8 SAE
 20227 FP 40-73-S1 06SAE
 20228 FP 40-87-S1 06SAE
 20229 FP 40-109 - S106SAE
 20230 FP 40-133- S106SAE



BOMBA CASAPPA KP

23601 KP20,4DO-82E2
 23603 KP20,6,3DO-82E2
 23602 KP20,8DO-82E2
 23617 KP20,11,2 DO-82E2
 23605 KP20,14 DO-82E2
 23609 KP20,16 DO-82E2
 23606 KP20,20DO-82E2
 23607 KP20,25DO-82E2
 23608 KP20,31,5DO-82E2



25000 Suporte de bomba - macho 1"3/8 Z6 SML4
 25002 Suporte de bomba - macho ZF-8 estrias SML 9
 25001 Suporte de bomba - macho 1"3/8 Z6 SML4
 25006 Suporte de bomba - F.Eng.Rap 1" 3/8 Z6 SFL 7/4

KIT E LUVAS

25045 Luva p/ mult. 14 Est Ext GR 2
 25044 Luva p/ mult. 18 Est Ext GR 3
 25040 Luva de veio B4/B4 MA6x21x25-31
 25047 Luva p/ bomba SAE Feme-MAF 06
 25048 Luva p/ bomba SAE Macho-MAF 06
 25020 Kit 10-A p/ FP20
 25021 Kit 17-A p/ veios B4/B4

CASAPPA



- 22974 AGREGADO PLP30,51/PLP 20,11,2 D/FS-L
- 24007 BOMBA KAPPA KP 30,27 83E3 -LED /EB-N
- 27007 MOTOR CARRETES KM30,43 LO-83 E3-LED/ED-N
- 37612 DIV. FLUXO HDD35,71-GG+C3535-GH+71GG+71GH
- 25001 SUPORTE DE BOMBA-FÊMEA 1"3/8 Z6 SFL 7/4
- 21210 BOMBA POL. PLP20-6,3-82E2 L EA/EA-N-EL-FS
- 21225 BOMBA PLP204DO 82E2 LEA/EA-N-EL-FS
- 22405 TAMPA FRONTAL PLP20-B4/AL
- 24408 CARRETO PRINCIPAL PLP 30/KP30,73-83
- 22425 KIT VEDANTES PLP 20
- 22455 CARRETE PRIMARIO PL30,73-83-6
- 37577 CARTUCHO FILTRO HF502-HEK02-20-201-AS-RP025
- 24386 BOMBA ANT KP30-67-83E3 DO
- 27065 MOTOR DE CARRETES KM 30,73R0-05S3-LGF/GG-N
- 27057 MOTOR PLM20 6,3R0-82E2 - LEA/EA-N-EL
- 27058 MOTOR PLM20 14 R0-82E2-LEA/EB-N-EL
- 27290 KIT VEDANTES KM30/KP-83E3-R-C4
- 24439 CORPO K30,38 - LED /ED (C/CASQUI.INCL.)

BOMBAS DE PISTONS



FILTROS DIVERSOS





MANGUEIRAS HIDRAULICAS

27545 SAE R1AT - 1/4"
27507 SAE R1AT - 5/16"
70065 SAE R1AT - 3/8"
54313 SAE R1AT - 1/2"
27033 SAE R1AT - 5,8"
27032 SAE R1AT - 3/4"
27537 SAE R1AT - 1"
27504 SAE R1AT - 1" - 1" 1/4
27538 SAE R2AT - 1/4"
27509 SAE R2AT - 5/16"
27510 SAE R2AT - 3/8"
27511 SAE R2AT - 1/2"
27512 SAE R2AT - 5/8"
27513 SAE R2AT - 3/4"
27540 SAE R2AT - 1"
57508 SAE R2AT - 1"1/4
27544 SAE R9R - 1/4"
27034 SAE R9R - 3/8"
27541 SAE R9R - 1/2"
27542 SAE R9R - 5/8"
27543 SAE R9R - 3/4"
27534 SAE R9R - 1"
70769 SAE R9R - 1"1/4



CILINDROS DUPLO EFEITO - S/ OLHAIS
SERIE 300

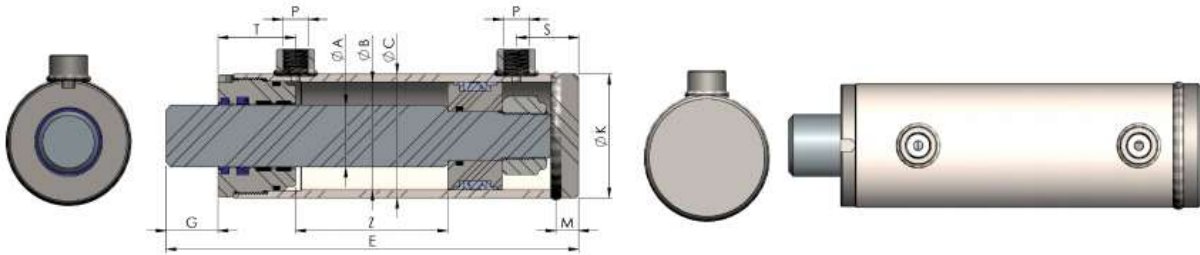

CODIGO	ØA	ØB	ØC	Z	E	P (BSP)	S	T	G	K	M	KIT JUNTAS	VOL (LT)	KGS +- (LT)
40571				100	233	G1/4						HJDE032040020	0,08	1,45
40414				150	233								0,08	1,45
40310				200	333								0,16	2,05
				250	333								0,16	2,05
				300	433								0,24	2,65
				350	433								0,24	2,65
40192	20	32	40	400	533		26	33	44	40	10		0,32	3,25
				450	533								0,32	3,25
				500	633								0,40	3,85
				550	633								0,40	3,85
				600	733								0,48	4,45
				650	733								0,48	4,45
				700	833								0,56	5,05
				750	833								0,56	5,05

CODIGO	ØA	ØB	ØC	Z	E	P (BSP)	S	T	G	K	M	KIT JUNTAS	VOL (LT)	KGS +- (LT)
				100	245	G3/8						HJDE040050025	0,13	2,65
40240				150	245								0,13	2,65
40226				200	345								0,25	3,55
40457				250	345								0,25	3,55
40191				300	445								0,38	4,45
40193				350	445								0,38	4,45
40117	25	40	50	400	545		31	43	28	50	15		0,50	5,35
39970				450	545								0,50	5,35
				500	645								0,63	6,25
				550	645								0,63	6,25
				600	745								0,75	7,15
				650	745								0,75	7,15
				700	845								0,88	8,05
				750	845								0,88	8,05

CILNDROS DUPLO EFEITO - S/ OLHAIS

SERIE 300

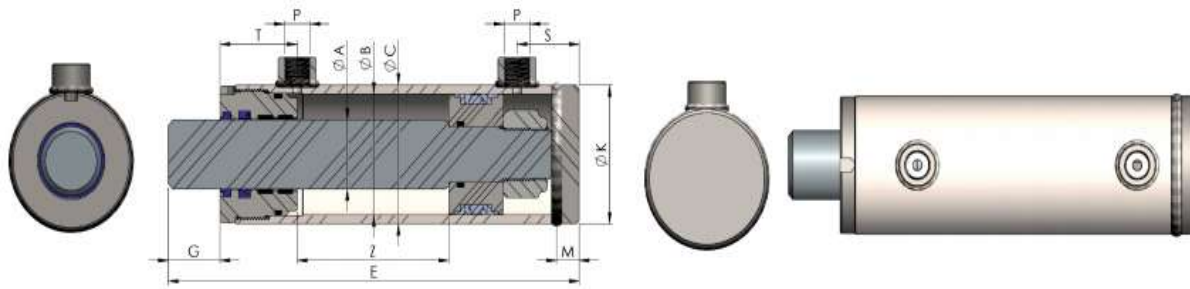

CODIGO	ØA	ØB	ØC	P							M	KIT JUNTAS	VOL (LT)	KGS +-	
				Z	E	(BSP)	S	T	G	K					
				100	270	G3/8							HJDE050060030	0,20	3,75
40249				150	270									0,20	3,75
40094				200	370									0,39	5,00
40183				250	370									0,39	5,00
40029				300	470									0,59	6,25
40136				350	470									0,59	6,25
40014	30	50	60	400	570									0,79	7,50
40409				450	570		35	43	47	60	15			0,79	7,50
				500	670									0,98	8,75
40145				550	670									0,98	8,75
40076				600	770									1,18	10,00
				650	770									1,18	10,00
				700	870									1,37	11,25
				750	870									1,37	11,25

CODIGO	ØA	ØB	ØC	P							M	KIT JUNTAS	VOL(LT)	KGS +-	
				Z	E	(BSP)	S	T	G	K					
				100	270	G3/8							HJDE040050025	0,28	4,75
				150	270									0,28	4,75
40094				200	370									0,57	6,10
				250	370									0,57	6,10
				300	470									0,85	7,45
				350	470									0,85	7,45
	30	60	70	400	570									1,13	8,80
				450	570		35	47	43	70	15			1,13	8,80
				500	670									1,41	10,15
				550	670									1,41	10,15
				600	770									1,70	11,50
				650	770									1,70	11,50
				700	870									1,98	12,85
				750	870									1,98	12,85

CILNDROS DUPLO EFEITO - S/ OLHAIS
SERIE 300

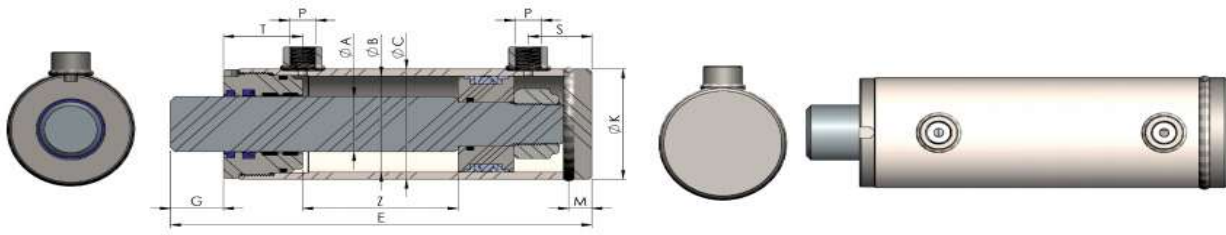

CODIGO	ØA	ØB	ØC	Z	E	P (BSP)	S	T	G	K	M	KIT JUNTAS	VOL (LT)	KGS +-
				100	270	G3/8							0,28	4,75
				150	270								0,28	4,75
40250				200	370								0,57	6,10
				250	370								0,57	6,10
40069				300	470								0,85	7,45
40480				350	470								0,85	7,45
				400	570								1,13	8,80
40408	35	60	70	450	570		35	47	43	70	15	HJDE040050025	1,13	8,80
				500	670								1,41	10,15
				550	670								1,41	10,15
				600	770								1,70	11,50
				650	770								1,70	11,50
				700	870								1,98	12,85
				750	870								1,98	12,85

CODIGO	ØA	ØB	ØC	Z	E	P (BSP)	S	T	G	K	M	KIT JUNTAS	VOL (LT)	KGS +-
				100	271	G3/8							0,39	6,70
				150	271								0,39	6,70
				200	371								0,77	8,60
				250	371								0,77	8,60
40123				300	471								1,15	10,50
40470				350	471								1,15	10,50
				400	571								1,54	12,40
	40	70	80	450	571		41	51	34	80	15	HJDE070080040	1,54	12,40
40210				500	671								1,92	14,30
				550	671								1,92	14,30
40068				600	771								2,31	16,20
				650	771								2,31	16,20
				700	871								2,69	18,10
				750	871								2,69	18,10



CILNDROS DUPLO EFEITO - S/ OLHAIS
SERIE 300

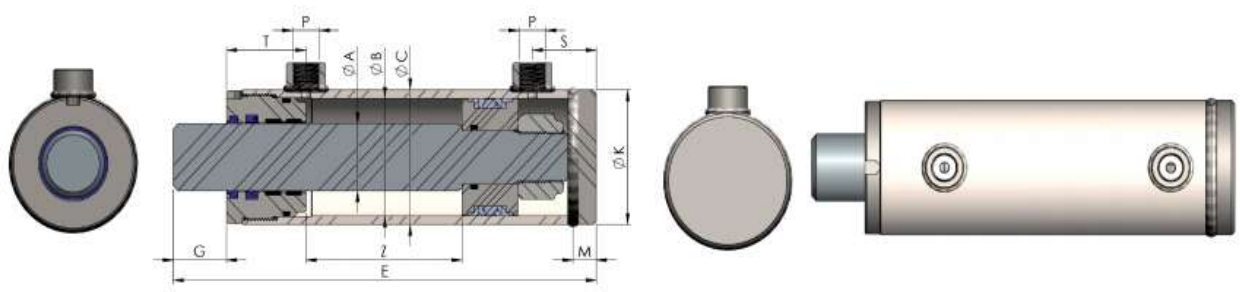

CODIGO	ØA	ØB	ØC	Z	E	P (BSP)	S	T	G	K	M	KIT JUNTAS	VOL (LT)	KGS +-
				100	271	G3/8							0,50	8,35
				150	271								0,50	8,35
				200	371								1,01	10,35
				250	371								1,01	10,35
				300	471								1,51	12,35
				350	471								1,51	12,35
	40	80	90	400	571		41	56	21	90	15	HJDE0800090040	2,01	14,35
				450	571								2,01	14,35
				500	671								2,51	16,35
				550	671								2,51	16,35
				600	771								3,01	18,35
				650	771								3,01	18,35
				700	871								3,51	20,35
				750	871								3,51	20,35

CODIGO	ØA	ØB	ØC	Z	E	P (BSP)	S	T	G	K	M	KIT JUNTAS	VOL (LT)	KGS +-
				100	281	G3/8							0,64	10,80
				150	281								0,64	10,80
				200	381								1,27	13,45
40309				250	381								1,27	13,45
				300	481								1,91	16,10
40478				350	481								1,91	16,10
	50	80	100	400	581		41	60	27	100	15	HJDE090100050	2,54	18,75
				450	581								2,54	18,75
40142				500	681								3,18	21,40
				550	681								3,18	21,40
				600	781								3,82	24,05
				650	781								3,82	24,05
				700	881								4,45	26,70
				750	881								4,45	26,70

CILNDROS DUPLO EFEITO - S/ OLHAIS

SERIE 300

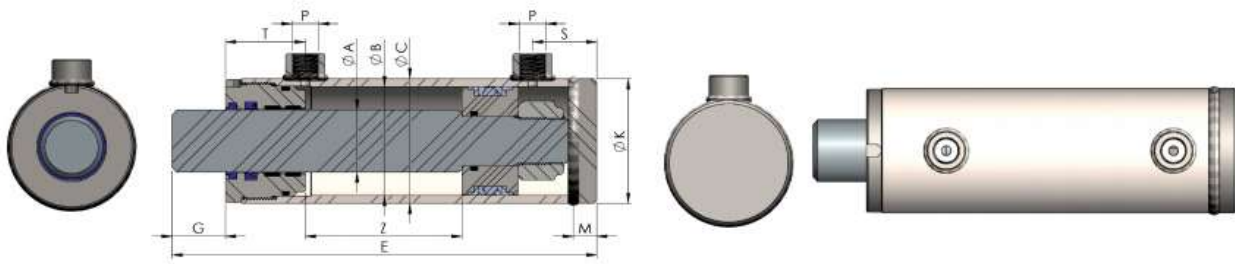

CODIGO	ØA	ØB	ØC	Z	E	P (BSP)	S	T	G	K	M	KIT JUNTAS	VOL (LT)	KGS +-	
				100	281	G3/8								0,64	10,80
				150	281									0,64	10,80
				200	381									1,27	13,45
				250	381									1,27	13,45
				300	481									1,91	16,10
				350	481									1,91	16,10
	50	90	100	400	581		41	60	27	100	15	HUDE090100050	2,54	18,75	
				450	581									2,54	18,75
				500	681									3,18	21,40
				550	681									3,18	21,40
				600	781									3,82	24,05
				650	781									3,82	24,05
				700	881									4,45	26,70
				750	881									4,45	26,70

CODIGO	ØA	ØB	ØC	Z	E	P (BSP)	S	T	G	K	M	KIT JUNTAS	VOL (LT)	KGS +-	
				100	286	G1/2								0,79	15,35
				150	286									0,79	15,35
				200	386									1,57	18,85
				250	386									1,57	18,85
				300	486									2,36	22,35
				350	486									2,36	22,35
	50	100	115	400	586		44	66	21	115	20	HUDE1000115050	3,14	25,85	
				450	586									3,14	25,85
				500	686									3,93	29,35
				550	686									3,93	29,35
				600	786									4,71	32,85
				650	786									4,71	32,85
				700	886									5,50	36,35
				750	886									5,50	36,35

CILNDROS DUPLO EFEITO - S/ OLHAIS



SERIE 300

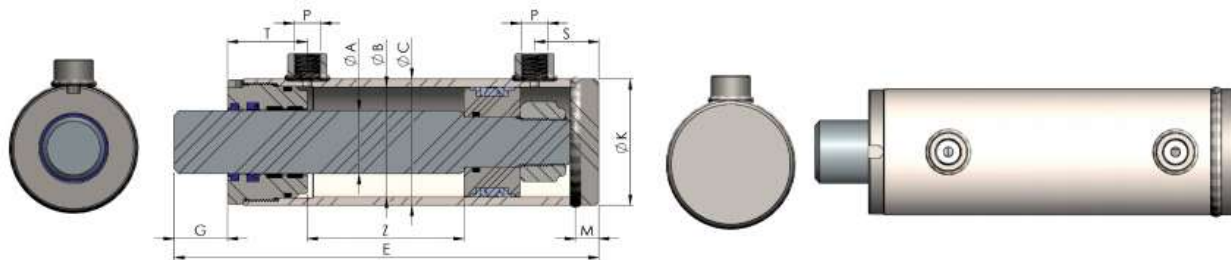

CODIGO	ØA	ØB	ØC	Z	E	P (BSP)	S	T	G	K	M	KIT JUNTAS	VOL (LT)	KGS +-
				100	315	G1/2							1,13	24,90
				150	315								1,13	24,90
				200	415								2,26	31,10
				250	415								2,26	31,10
				300	515								3,39	37,30
				350	515								3,39	37,30
	70	120	140	400	615		50	68	33	139	20	HJDE120140070	4,52	43,50
				450	615								4,52	43,50
				500	715								5,65	49,70
				550	715								5,65	49,70
				600	815								6,78	55,90
				650	815								6,78	55,90
				700	915								7,91	62,10
				750	915								7,91	62,10

CODIGO	ØA	ØB	ØC	Z	E	P (BSP)	S	T	G	K	M	KIT JUNTAS	VOL (LT)	KGS +-
				100	410	G3/4							1,33	31,65
				150	410								1,33	31,65
				200	510								2,65	39,00
				250	510								2,65	39,00
				300	610								3,98	46,35
				350	610								3,98	46,35
	80	130	150	400	710		50	75	31	149	20	HJDE130150080	5,31	53,70
				450	710								5,31	53,70
				500	810								6,63	61,05
				550	810								6,63	61,05
				600	910								7,96	68,40
				650	910								7,96	68,40
				700	1010								9,29	75,75
				750	1010								9,29	75,75

CILNDROS DUPLO EFEITO - C/ OLHAIS

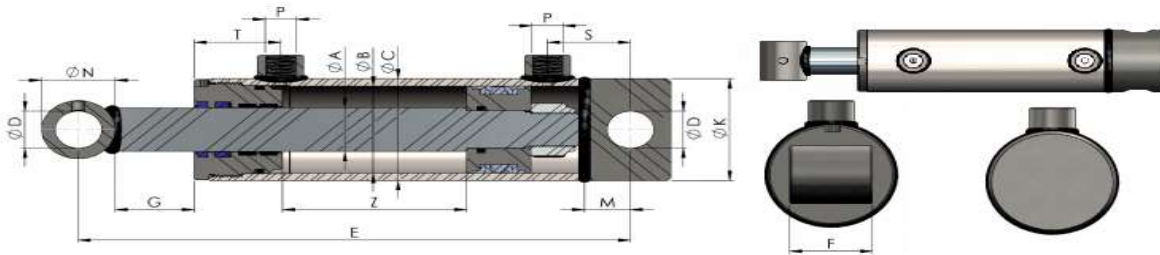

SERIE 200

COD.	ØA	ØB	ØC	Z	E	ØD	P (BSP)	S	T	ØN	G	F	K	M	KIT JUNTA	VOL (LT)	KGS
40367				100	255										S	0,08	1,75
				150	255										K	0,08	1,75
40629				200	355										J	0,16	2,35
				250	355										D	0,16	2,35
				300	455										E	0,24	2,95
				350	455										0	0,24	2,95
				400	555	16,25	G								3	0,24	2,95
	20	32	40	450	555	16,25	1	33	33	30	44	35	40	17	2	0,32	3,55
				450	555	16,25	/								0	0,32	3,55
39905				500	655		4								4	0,4	4,15
				550	655										0	0,4	4,15
40357				600	755										0	0,48	4,75
				650	755										0	0,48	4,75
40515				700	855										2	0,56	5,35
				750	855										0	0,56	5,35

COD.	ØA	ØB	ØC	Z	E	ØD	P (BSP)	S	T	ØN	G	F	K	M	KIT JUNTA	VOL (LT)	KGS
				100	270										S	0,13	3,10
				150	270										K	0,13	3,10
40374				200	370										J	0,25	4,05
				250	370										D	0,25	4,05
				300	470										E	0,38	5,00
				350	470										0	0,38	5,00
				400	570	20,5	G								3	0,38	5,00
	25	40	50	450	570	20,5	3	38	43	35	28	40	50	22	2	0,50	5,95
				450	570	20,5	/								0	0,50	5,95
40452				500	670		8								5	0,63	6,95
				550	670										0	0,63	6,95
				600	770										0	0,75	7,85
				650	770										0	0,75	7,95
				700	870										2	0,88	8,80
				750	870										5	0,88	8,80

CILNDROS DUPLO EFEITO - C/OLHAIS

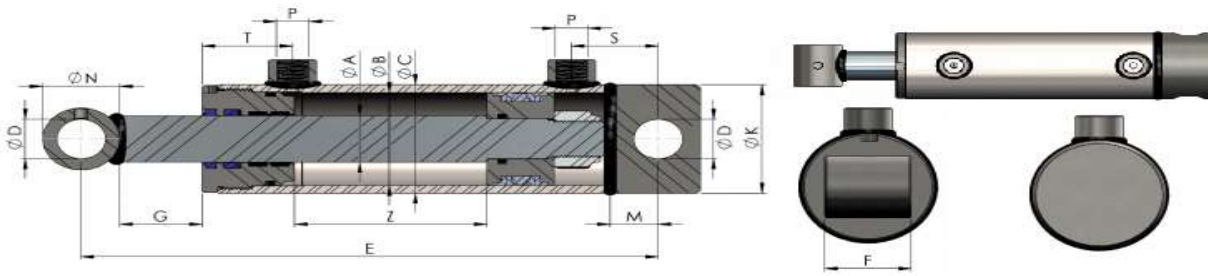

SERIE 200

COD.	ØA	ØB	ØC	Z	E	ØD	P (BSP)	S	T	ØN	G	F	K	M	KIT JUNTA	VOL (LT)	KGS	
39717	30	50	60	100	300	25,5	G	45	43	40	47	45	60	25	S	0,20	4,50	
				K	0,20										4,50			
				J	0,39										5,70			
				D	0,39										5,70			
				E	0,59										6,90			
				0	0,59										6,90			
40218	30	50	60	400	600	25,5	1	45	43	40	47	45	60	25	2	0,79	8,10	
				450	600										/	0	0,79	8,10
				500	700										4	4	0,98	9,30
				550	700										0	0	0,98	9,30
40372	30	60	70	600	800	25,5	0	45	47	40	43	45	70	25	0	1,18	10,50	
				650	800										0	0	1,18	10,50
				700	900										3	3	1,37	11,70
				750	900										0	0	1,37	11,70

COD.	ØA	ØB	ØC	Z	E	ØD	P (BSP)	S	T	ØN	G	F	K	M	KIT JUNTA	VOL (LT)	KGS	
	30	60	70	100	270	25,5	G	45	47	40	43	45	70	25	S	0,28	5,70	
				K	0,28										5,70			
				J	0,57										7,05			
				D	0,57										7,05			
				E	0,85										8,40			
				0	0,85										8,40			
	30	60	70	400	570	25,5	3	45	47	40	43	45	70	25	2	1,13	9,75	
				450	570										/	0	1,13	9,75
				500	670										8	5	1,41	11,10
				550	670										0	0	1,41	11,10
				600	770										0	0	1,70	12,45
				650	770										0	0	1,70	12,45
				700	870										3	3	1,98	13,80
				750	870										0	0	1,98	13,80

CILNDROS DUPLO EFEITO - C/ OLHAIS

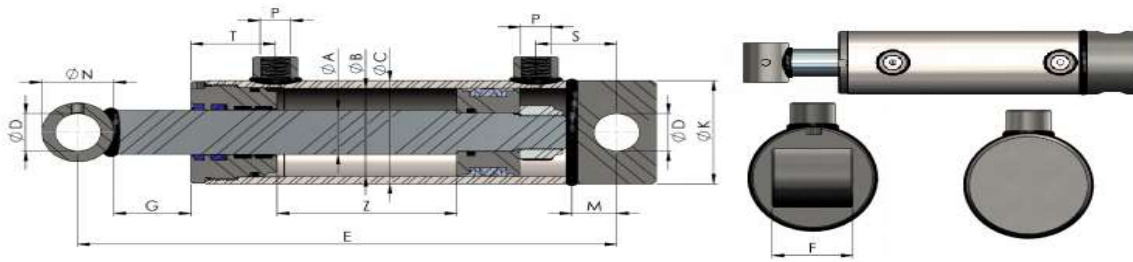

SERIE 200

COD.	ØA	ØB	ØC	Z	E	ØD	P (BSP))	S	T	ØNG	F	K	M	KIT JUNTA	S	VOL (LT)	KGS	
				100	270												0,28	5,70	
				150	270											K	0,28	5,70	
				200	370											J	0,57	7,05	
				250	370											D	0,57	7,05	
40513				300	470											E	0,85	8,40	
				350	470		G									0	0,85	8,40	
40438	35	60	70	400	570	25,5	1		45	43	40	47	45	60	25	3	1,13	9,75	
40649				450	570		/									5	1,13	9,75	
40343				500	670		4									0	1,41	11,10	
				550	670											6	1,41	11,10	
40491				600	770											0	1,70	12,45	
				650	770											0	1,70	12,45	
40321				700	870											3	1,70	12,45	
				750	870											5	1,98	13,80	
																	5	1,98	13,80

COD.	ØA	ØB	ØC	Z	E	ØD	P (BSP))	S	T	ØNG	F	K	M	KIT JUNTA	S	VOL (LT)	KGS	
				100	310												0,39	8,30	
				150	310												K	0,39	8,30
40516				200	410												J	0,77	10,20
				250	410												D	0,77	10,20
				300	510												E	0,77	10,20
				350	510		G									0	1,15	12,10	
				400	610		3									7	1,15	12,10	
40304	40	70	80	450	610	30,5	/		55	51	50	34	55	80	29	0	1,54	14,00	
				500	710		8									0	1,54	14,00	
40173				550	710											8	1,92	15,90	
				600	810											0	1,92	15,90	
40342				650	810											0	2,31	17,80	
				700	910											0	2,31	17,80	
				750	910											4	2,69	19,70	
																0	2,69	19,70	

CILNDROS DUPLO EFEITO - C/ OLHAIS

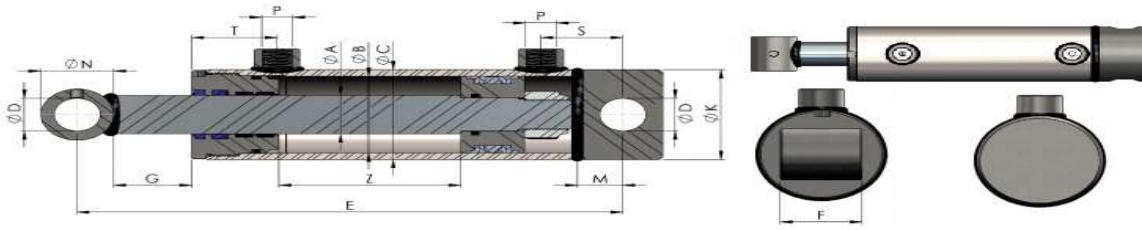

SERIE 200

COD.	ØA	ØB	ØC	Z	E	ØD	P (BSP)	S	T	ØNG	F	K	M	KIT JUNTA	VOL (LT)	KGS	
40526				100	310									S	0,50	10,35	
				150	310									K	0,50	10,35	
				200	410									J	1,01	12,35	
				250	410									D	1,01	12,35	
40471				300	510									E	1,51	14,35	
				350	510		G							0	1,51	14,35	
40481	40	80	90	400	610	30,5	3	55	56	50	21	55	90	29	8	2,01	16,35
				450	610		/								0	2,01	16,35
				500	710		8								9	2,51	18,35
				550	710										0	2,51	18,35
				600	810										0	3,01	20,35
				650	810										4	3,01	20,50
				700	910										0	3,51	22,35
				750	910										0	3,51	22,35

COD.	ØA	ØB	ØC	Z	E	ØD	P (BSP)	S	T	ØNG	F	K	M	KIT JUNTA	VOL (LT)	KGS		
40341				100	325									S	0,50	10,35		
				150	325									K	0,50	10,35		
				200	425									J	1,01	12,35		
				250	425									D	1,01	12,35		
				300	525									E	1,51	14,35		
				350	525		G							0	1,51	14,35		
		50	80	100	400	625	30,5	3	55	60	60	27	70	100	29	9	2,01	16,35
	450				625	/		0								2,01	16,35	
				500	725		8							1	2,51	18,35		
				550	725									0	2,51	18,35		
				600	825									0	3,01	20,35		
				650	825									5	3,01	20,35		
				700	925									0	3,51	22,35		
				750	925									0	3,51	22,35		

CILNDROS DUPLO EFEITO - C/ OLHAIS

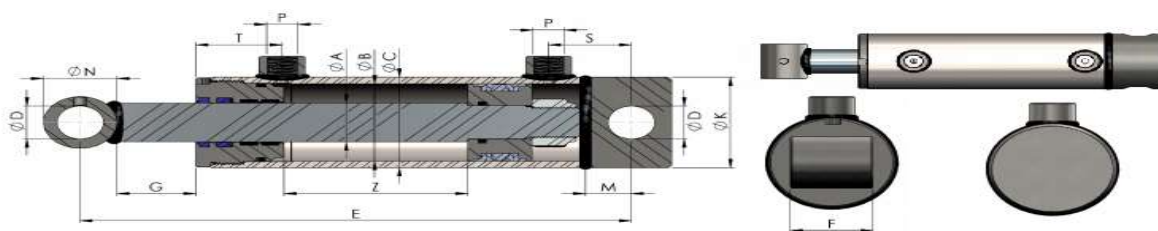

SERIE 200

COD.	ØA	ØB	ØC	Z	E	ØD	P (BSP)	S	T	ØN	G	F	K	M	KIT JUNTAS	VOL (LT)	KGS
				100	325											0,64	13,90
				150	325										K	0,64	13,90
				200	425										J	1,27	16,60
				250	425										D	1,27	16,60
				300	525										E	1,91	19,30
				350	525		G								O	1,91	19,30
	50	90	100	400	625	30,5	3	55	60	60	27	70	100	29	9	2,54	22,00
40628				450	625		/								0	2,54	22,00
				500	725		8								1	3,18	24,70
				550	725										0	3,18	24,70
40241				600	825										0	3,82	27,40
				650	825										5	3,82	27,40
				700	925										0	4,45	30,10
				750	925											4,45	30,10

COD.	ØA	ØB	ØC	Z	E	ØD	P (BSP)	S	T	ØN	G	F	K	M	KIT JUNTAS	VOL (LT)	KGS
				100	325											0,79	19,10
				150	325										K	0,79	19,10
				200	425										J	1,57	22,60
				250	425										D	1,57	22,60
				300	525										E	2,36	26,10
				350	525		G								1	2,36	26,10
40404	50	100	115	400	625	30,5	1	53	66	60	21	70	115	29	0	3,14	29,60
				450	625		/								0	3,14	29,60
				500	725		2								1	3,93	33,10
				550	725										1	3,93	33,10
				600	725										5	3,93	33,10
				650	725										0	4,71	36,60
				650	725										5	4,71	36,60
				700	925										0	5,50	40,10
				750	925											5,50	40,10

CILNDROS DUPLO EFEITO - C/ OLHAIS

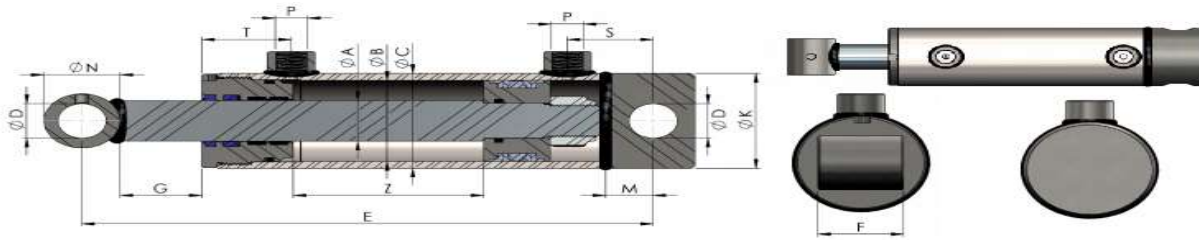

SERIE 200

COD.	ØA	ØB	ØC	Z	E	ØD	P (BSP)	S	T	ØN	G	F	K	M	KIT JUNTAS	VOL (LT)	KGS
				100	370											1,13	32,45
				150	370										K	1,32	32,45
				200	470										J	2,26	38,65
				250	470										D	2,26	38,65
				300	570										E	3,39	44,85
				350	570		G								1	3,39	44,85
	70	120	140	400	670	40,5	1	65	68	80	33	80	139	35	2	4,52	51,05
				450	670		/								0	4,52	51,05
				500	770		2								1	5,65	57,25
				550	770										4	5,65	57,25
				600	870										0	6,78	63,45
				650	870										0	6,78	63,45
40413				700	970										7	6,78	63,45
				750	970										0	7,91	69,65
																7,91	69,65

COD.	ØA	ØB	ØC	Z	E	ØD	P (BSP)	S	T	ØN	G	F	K	M	KIT JUNTAS	VOL (LT)	KGS
				100	410											1,33	43,55
				150	410										K	1,33	43,55
				200	510										J	2,65	50,90
				250	510										D	2,65	50,90
				300	610										E	3,98	58,25
				350	610		G								1	3,98	58,25
	80	130	150	400	710	50,5	3	80	75	90	31	100	149	50	3	5,31	65,60
				450	710		/								0	5,31	65,60
				500	810		4								1	6,63	72,95
				550	810										5	6,63	72,95
				600	910										0	7,96	80,30
				650	910										0	7,96	80,30
				700	1010										8	7,96	80,30
				750	1010										0	9,29	87,65
																9,29	87,65

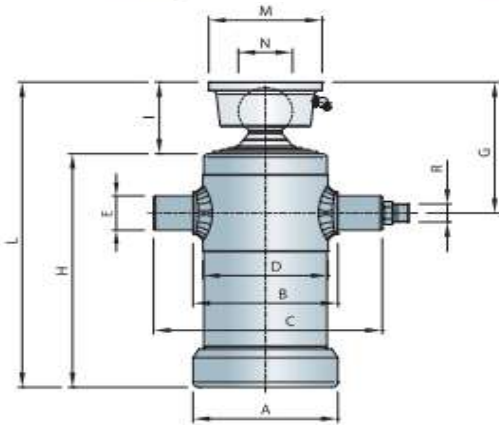
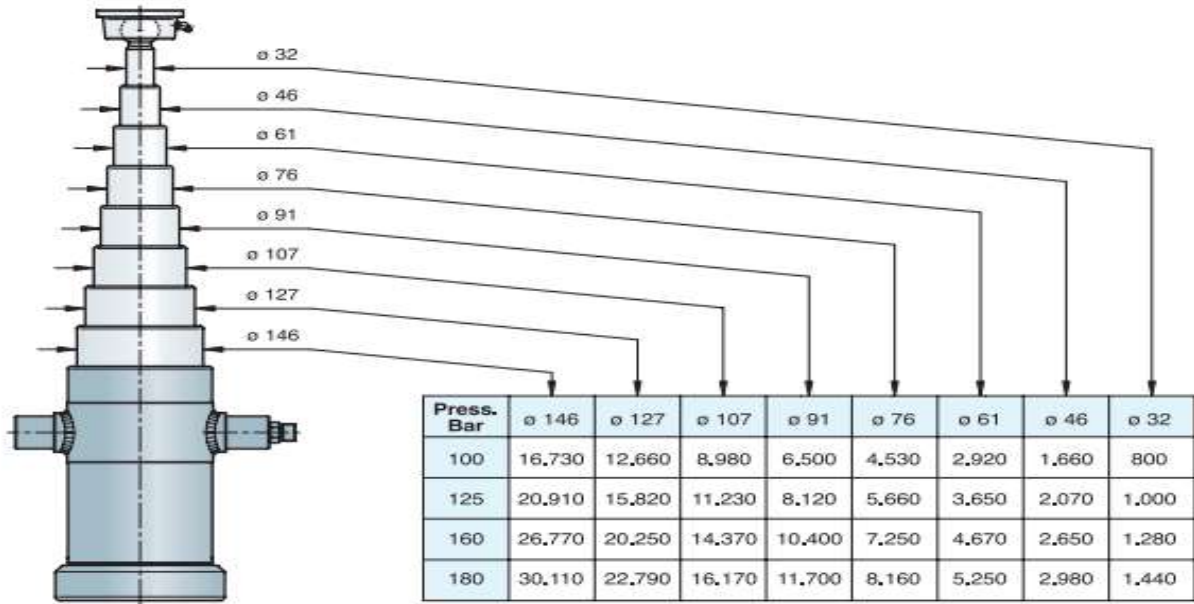

CILINDRO HIDRAULICO C/ESFERA PARA BASCULAS

N/Codigos	Referencia	Capid.	A	B	C	D	E	G	H	I	L	M	N	R	PESO
39719 60-03-30	100,060,03,30	3 TON	110	115	200	95	35	142	278	69	347	100	45	1/2"	16
39837 70-03-30	100,070,03,30	3 TON	110	115	200	95	35	142	311	69	380	100	45	1/2"	17
39899 80-03-30	100,080,03,30	3 TON	110	115	200	95	35	142	345	69	414	100	45	1/2"	19
39923		3 TON													
40306 80-03-50	100,080,03,50	5 TON	130	135	220	114	35	153	345	82	427	115	55	1/2"	27
40616 85-04-50	100,085,04,50	5 TON	130	135	220	114	35	142	289	71	360	100	45	1/2"	22
40498 115-03-50	100,115,03,50	5 TON	130	135	220	114	35	153	461	82	543	115	55	1/2"	35
40602 115-04-50	100,115,04,05	5 TON	130	135	220	114	35	142	364	71	435	100	45	1/2"	27
39640		5 TON													
39638 150-05-50	100,150,05,50	5 TON	145	150	232	127	40	142	378	73	451	100	45	1/2"	33
40013 85-04-80	100,085,04,80	8 TON	145	150	232	127	40	153	291	84	375	115	55	1/2"	28
39615 950-04-80	100,095,04,80	8 TON	145	150	232	127	40	153	316	84	400	115	55	1/2"	30
39884 105-04-80	100,105,04,80	8 TON	145	150	232	127	40	153	341	84	425	115	55	1/2"	32
39613 120-04-80	100,120,04,80	8 TON	145	150	232	127	40	153	378	84	462	115	55	1/2"	35
40497 130-04-80	100,130,04,80	8 TON	145	150	232	127	40	153	404	84	488	115	55	1/2"	36
39614 150-04-80	100,150,04,80	8 TON	145	150	232	127	40	153	454	84	538	115	55	1/2"	40
39639		9 TON													
40622 100-04-120	100,100,04,12	12 TON	170	175	262	152	45	152	344	83	427	115	55	1/2"	53
39859 150-04-180	100,150,04,18	18 TON	195	200	293	168	50	203	473	92	565	107	65	3/4"	64



GÔNDOLAS TRILATERAL

39784	T1D35 120/30/96
39724	T2D35 112x136
39606	T3D40 124x156
39752	T4D50 152x186

SUPORTE CILINDRO

39785	Hidraulico 35
39607	Hidraulico 40
39665	CA-11
39674	Aberto P/cilindro hidr. 40
39712	Aberto P/cilindro hidr. 50
39699	Aberto P/cilindro hidr. 45

COPA COMPLETA PARA CILINDRO

40496	Sem Esfera 45
40324	Sem Esfera 55
40037	Sem Esfera 65
40427	Com Esfera 45
40426	Com Esfera 55
40453	Com Esfera 65
39880	Meia lua p/copa D45 S/freio
39919	Freio D.65 p/copa D46
39906	Meia lua p/copa D55 S/freio
39933	Freio D.75 p/copa D46